

view5x

User Manual

Core Alignment
Fusion Splicer



Contents

Chapter 1 Installation	5
1.1 Safety Warning and Precautions.....	5
1.2 Battery Precautions.....	6
1.3 Installation.....	6
1.4 Overview of External Parts.....	7
1.5 Power Supply Method.....	8
Chapter 2 Basic Operation	9
2.1 Turning On the Splicer.....	9
2.2 Preparing the Fiber.....	9
2.3 How to Make a Splice.....	10
2.4 How to Protect the Splice.....	11
Chapter 3 Splice Mode	12
3.1 Displaying the Active Splice Mode.....	12
3.2 Selecting a Splice Mode.....	12
3.3 General Splicing Steps.....	13
3.4 Standard Splicing Parameters.....	14
Chapter 4 Splice Option	15
4.1 Splice Mode Settings.....	15
Chapter 5 Heater Mode	16
5.1 Selecting Heater Mode.....	16
5.2 Editing Heat Mode.....	16
5.3 Delete Heat Mode.....	17
Chapter 6 Maintenance Menu	18
6.1 Maintenance.....	18
6.2 Replace Electrodes.....	18
6.3 Stabilize Electrodes.....	19
6.4 Motor Calibration.....	19
6.5 Arc Calibration.....	19
Chapter 7 View Pro Manager & Device Settings	21
7.1 How To Register your Device	21
7.2 Calendar.....	22
7.3 Supervisor Mode.....	22
7.4 Service Request.....	24

Chapter 8 Utilities	26
8.1 System Settings.....	26
8.2 System Information.....	26
Appendix I.....	27
Appendix II.....	28
Appendix III.....	30

Preface

Thank you for choosing the View 5X Fusion Splicer from INNO Instrument. The View 5X is a Core Alignment Fusion Splicer with AI-Driven Features and embedded IoT & GPS Modules. As well as this, the completely new technology greatly reduces splicing and heating time. The advanced estimation method and alignment technique ensures accurate splice loss estimation. The new product design, sophisticated internal structure and reliable durability makes the splicer suitable for any operating environment. Dynamic operation interface and automatic splice mode provide users great convenience. For more information of the View 5X, please visit our official website at www.innoinstrument.com.



This User Manual explains the use, performance characteristics, and cautions of the View 5X fusion splicer and how to install and operate it. The primary goal of this manual is to make the user as familiar with the splicer as possible.

⚠ Important!

INNO Instrument recommends all users to read this manual before operating the View 5X fusion splicer.

Chapter 1 - Installation

1.1 Safety Warning and Precautions

As View 5X is designed for fusion splicing silica glass optical fibers, it is very important that the splicer should not be used for any other purposes. The splicer is a precision instrument and must be handled with caution. Therefore, you should read the following safety rules and general precautions in this manual. Any actions that do not follow the warnings and cautions will break the safety standard of design, manufacture, and usage of the fusion splicer. INNO Instrument will not take any responsibility for the consequences caused by misuse.

Operational Safety Warnings

- Never operate the splicer in flammable or explosive environment.
- DO NOT touch the electrodes when the splicer is on.

Note:

Only use specified electrodes for the fusion splicer. Select [Replace electrode] in the Maintenance Menu to replace electrodes, or turn off the splicer, disconnect the AC power source and remove battery before replacing electrodes. Do not initiate the arc discharge unless both electrodes are properly in place.

- Do not disassemble or alter any components of the splicer without approval, except for the components or parts explicitly permitted for disassembly or modification by users as outlined in this manual. Component replacement and internal adjustments should only be carried out by INNO or its authorized technicians or engineers.
- Avoid operating the splicer in environments containing flammable liquids or vapors, as the electrical arc produced by the splicer could pose a risk of dangerous fire or explosion. Refrain from using the splicer near heat sources, in high-temperature and dusty environments, or when condensation is present on the splicer, as this may lead to electric shock, splicer malfunction, or compromised splicing performance.
- It is imperative to wear safety glasses during fiber preparation and splicing operations. Fiber fragments can pose a significant danger if they come into contact with the eyes, skin, or if ingested.
- Remove the battery promptly if any of the following issues are noticed while using the splicer:
 - Fumes, unpleasant odors, abnormal noises, or excessive heat.
 - Liquid or foreign matter enters the splicer body (casing).
 - The splicer is damaged or dropped.
 - In case of any of these faults, please reach out to our service center immediately. Allowing the splicer to remain in a damaged state without prompt action may lead to equipment failure, electric shock, fire, and could result in injury or death.
- Avoid utilizing compressed gas or canned air for cleaning the splicer, as these products may contain flammable materials that could ignite during electrical discharge.
- Utilize only the designated standard battery for View 5X. The use of an incorrect AC power source may lead to fuming, electric shock, equipment damage, and potentially result in fire, injury, or death.
- Use only the specified charger for View 5X. Avoid placing heavy objects on the AC power cord and ensure it is kept away from heat sources. The use of an improper or damaged cord may cause fuming, electric shock, equipment damage, and may even result in fire, injury, or death.

Maintenance and External Care Precautions

- Refrain from using hard objects to clean V-grooves and electrodes.
- Avoid the use of acetone, thinner, benzol, or alcohol for cleaning any part of the splicer, except in the recommended areas.
- Use a dry cloth to eliminate dust and dirt from the splicer.
- Always follow the maintenance instructions in this manual.

Transport and Storage Precautions

- When transporting or moving the splicer from a cold to a warm environment, it is essential to allow the fusion splicer to warm up gradually to prevent condensation inside the unit, which can have harmful effects on the splicer.
- Pack the fusion splicer well for long term storage.
- Keep the splicer clean and dry.
- Given its precision adjustments and alignment, store the splicer in its carrying case at all times to protect it from damage and dirt.
- Always avoid leaving the splicer in direct sunlight or exposed to excessive heat.
- Do not store the splicer in dusty environment. This may result in electric shock, splicer malfunction or poor splicing performance.
- Keep the humidity to a minimum level where the splicer is stored. The humidity must not exceed 95%.

1.2 Battery precautions

- Avoid touching or striking the battery with pointed or sharp objects.
- Keep the battery away from metal materials and objects.
- Refrain from throwing, dropping, impacting, or bending the battery, and avoid knocking or stomping on it.
- Do not connect the battery's anode and cathode terminals with metals like electric wire to prevent potential short circuits.
- Ensure that the battery's anode or cathode terminal does not come into contact with the aluminum layer of the packaging, as it may cause a short circuit.
- Do not disassemble the battery cell.
- Avoid immersing the battery in water, as water damage will render the battery cell inoperable.
- Do not place or use the battery near heat sources, such as fire, and prevent the battery from getting excessively hot.
- Refrain from directly soldering the battery and avoid charging it in very hot environments.
- Do not place the battery in a microwave oven or any high-pressure vessel.
- Keep the battery away from hot environments, such as inside a car for extended periods or in direct sunlight.
- It is strictly forbidden to use a damaged battery.
- In case of electrolyte leakage, keep the battery away from any fire source.
- If the battery emits an electrolyte smell, do not use it.

1.3 Installation

Important!

Follow these instructions carefully.

Unpacking the Splicer

Hold the handle upwards, and then lift the splicer out of the carrying case.

1.4 Overview of External Parts

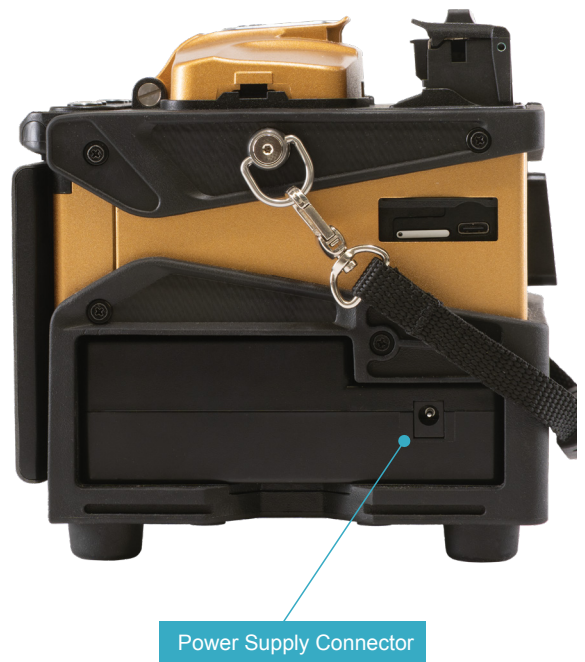

1.5 Power Supply Method

Battery

The following diagram presents how to install the battery.

1. Switch off the Fusion Splicer

Press the release button, this will allow you to slide the battery out of the fusion splicer.



2. Push the battery



3. Place the battery into the power unit slot Push it into the right place.

Chapter 2 - Basic Operation

2.1 Turning On the Splicer

Press  button on the operation panel, wait for the splicer to turn on. Then move to the Workbench page.

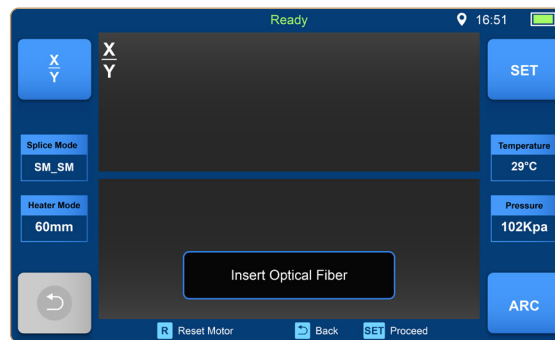

Note:

The LCD monitor is a precise component produced by our manufacturing factory under strict quality control. However, some tiny dots in different colors may still remain on the screen. Meanwhile, the screen brightness may not appear uniform, depending on the viewing angle. Note that these symptoms are not defects, but natural phenomena.

2.2 Preparing the Fiber

These 3 steps should be carried out before splicing:

1. Stripping: Remove at least 50mm of secondary coating (valid for both tight and loose tube secondary coating) and approximately 30~40mm of primary coating with an appropriate stripper.
2. Clean bare fibers with pure alcohol-soaked gauze or lint-free tissue.
3. Cleave the fiber: In order to ensure the best splicing result, cleave the fibers with a high precision cleaver such as INNO Instrument V series fiber cleaver, and strictly control the cleaving lengths shown as below.

Note:

Always remember to slip a heat-shrinkable sleeve onto either end of the fibers at the beginning of each fiber preparation.

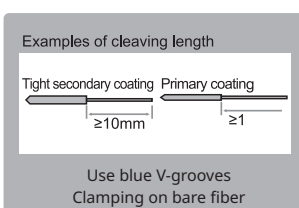

Important!

Make sure that the bare fiber and its cleaved section are clean.

- Avoid putting the fibers down on a dusty working surface.
- Avoid waving the fibers around in the air.
- Check if the V-grooves are clean; if not, wipe them clean with pure alcohol-soaked cotton swab.
- Check whether the clamps are clean; if not, wipe them clean with pure alcohol-soaked cotton swab.

2.3 How to Make a Splice

- Open the windproof cover.
- Open the fiber clamps.
- Place the fibers into V-grooves. Make sure the fiber ends are between the V-groove edges and the electrode tip.
- Clamp the fiber in position by closing both sets of fiber clamps.
- Close the windproof cover.

⚠ Note:

Make sure to avoid sliding the fibers along V-grooves, but rather position them over V-grooves and tilt them down into place (as shown below).

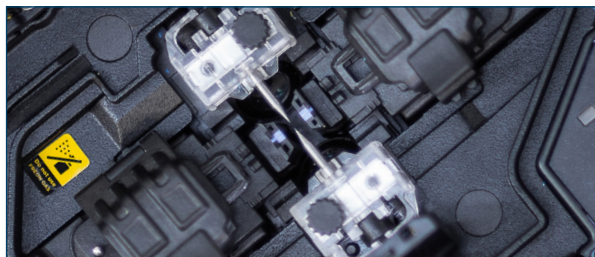
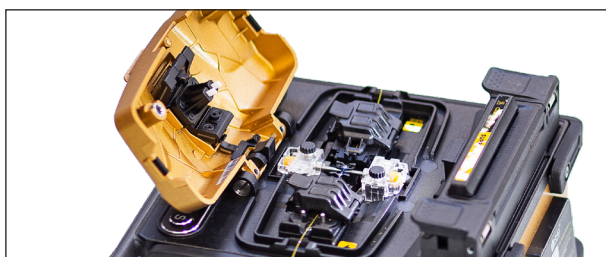
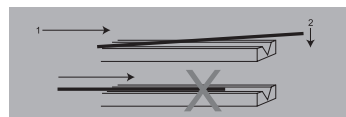

Inspecting the Fibers

Before continuing with splicing, inspect the fibers to check whether they are clean and well cleaved. If any defects are found, please remove the fibers and prepare them again.

a.

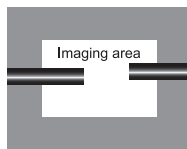

Fiber ends visible on the monitor.

b.

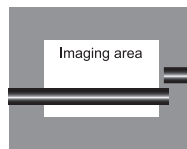

Fiber ends outside monitor.

c.

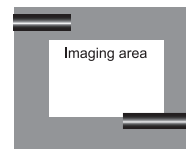

Fiber ends above and below monitor - not detectable.

⚠ Note:

The fibers are checked automatically when you press Set button. The splicer automatically focuses on the fibers and checks for damage or dust particles.

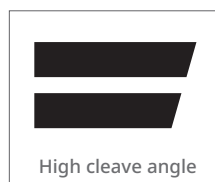
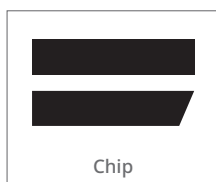
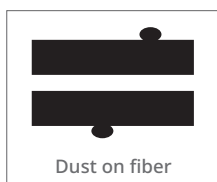

Splicing

Select an appropriate splice mode.
Start splicing by pressing "SET" button.

⚠ Note:

If the splicer is set to "Auto Start", splicing will start automatically once the windproof cover is closed.

2.4 How to Protect the Splice

After splicing, put the fiber with heat-shrink sleeve into the heater. Press [Heat] button to start the heating process.

Heating Procedure

- Open the heater lid
- Open the left and right fiber holders. Hold the heat-shrink sleeve (previously placed onto the fiber). Lift the spliced fibers and hold them tight. Then slide the heat-shrink sleeve to the splice point.
- Place the fiber with heat-shrink sleeve in the heater clamp.
- Press [Heat] button to start heating. Upon completion, the heating LED indicator will switch off.

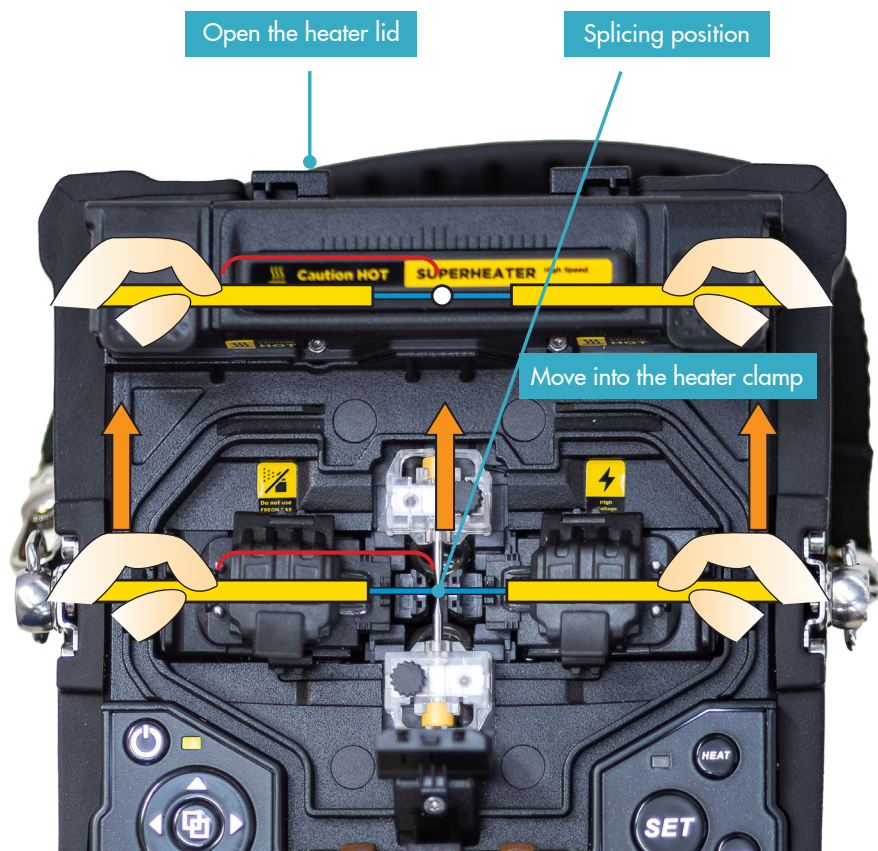

Chapter 3 - Splice Mode

View 5X has a variety of simple but very powerful splice modes which define arc currents, splice times as well as various parameters used when performing a splice. It is essential to select the correct splice mode. There are a number of "Preset" splice modes for common fiber combinations. Therefore, it is much easier to modify and further optimize the parameters for more unusual fiber combinations.

3.1 Displaying the Active Splice Mode

The active splice mode is always displayed on the left side of the screen (see below).



3.2 Selecting a Splice Mode

Select [Splice mode] from the Main Menu.

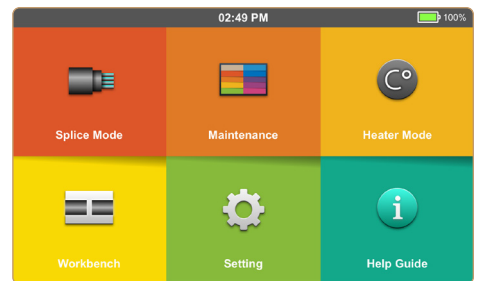

Select an appropriate splice mode

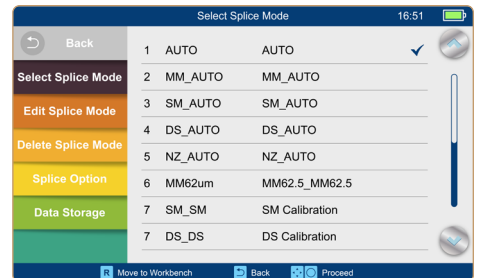

Selected splice mode appears on the screen.
Press [Reset] button to return to the initial interface page.

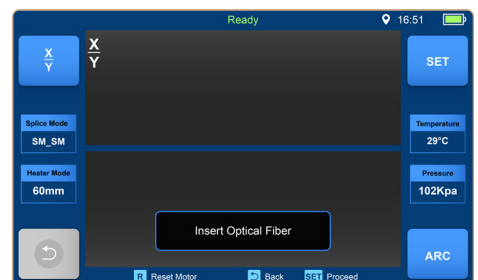

3.3 General Splicing Steps

This section explains the steps involved in automatic splicing process and describes how various splice mode parameters are related to this process. The normal splicing process can be divided into two sections: pre-fusion and fusion.

Pre-Fusion

During pre-fusion, the splicer performs automatic alignment and focusing, where the fibers are subject to a low pre-fusion current for cleaning purposes; a pre-fusion image is also taken. At this point, the user is informed of any problems recognized in the pre-fusion image, such as a poorly prepared fibers. The splicer will then display a warning before the fibers are fused together.

Fusion

During fusion, the fibers are joined together and subjected to five different currents as illustrated below. An important parameter, which changes during splicing, is the distance between the fibers. During Pre-fusion, the fibers are apart. With the current phase changing, fibers are spliced gradually.

Splicing Process

Arc power and arc time are considered as the two most important parameters (as shown in the figure below). The name and purpose of those parameters, as well as the effect and importance of the parameters, will be described in the next section 'Standard Splicing Parameters'. The below figure shows the arc discharge conditions (relationship between "Arc power" and "Motor motion"). These conditions can be modified by changing the splicing parameters listed below. However, depending on the splice mode, certain parameters cannot be changed.

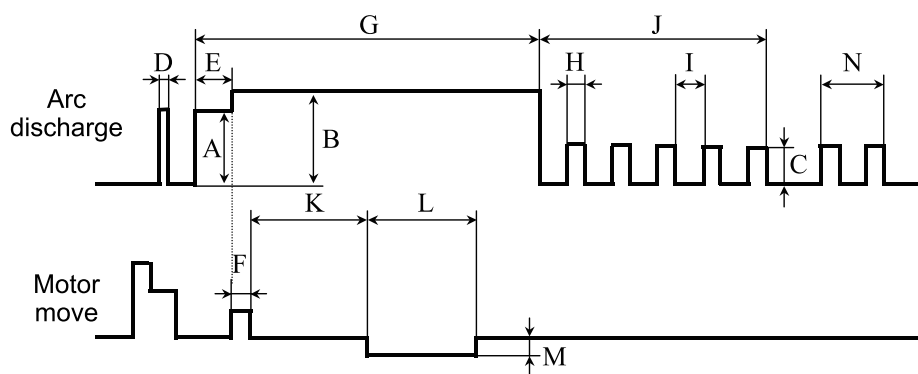

- A: Pre-fuse power
- B: Arc 1 power
- C: Arc 2 Power
- D: Cleaning Arc
- E: Pre-fuse Time
- F: Forward Time related to Overlap
- G: Arc 1 time
- H: Arc 2 ON time
- I: Arc 2 OFF time
- J: Arc 2 time
- K: Taper Splicing Wait Time
- L: Taper Splicing Time
- M: Taper Splicing speed
- N: Re-arc Time

Diagram of ARC discharge condition

3.4 Standard Splicing Parameters

Parameter	Description
Template	A list of splice modes stored in the splicer database is displayed. Upon selecting the appropriate mode, the selected splice mode settings are copied to a selected splice mode in the user-programmable area.
Name	Title for a splice mode (up to seven characters)
Note	Detailed explanation for a splice mode (up to 15 characters). It is displayed in the "Select splice mode" menu.
Align Type	Set the alignment type for the fibers. "Core" : fiber core alignment
Arc adjust	Adjust arc power according to the fibers' conditions.
Pull test	If "Pull test" is set to "ON", a pull test is performed upon opening the windproof cover or by pressing the SET button after splicing.
Loss estimate	Loss estimation should be regarded as a reference. Since the loss is calculated based on the fiber image, it may differ from the real value. The estimation method is based on a single mode fiber and calculated at the wavelength of 1.31 μ m. The estimated value can be a valuable reference, but cannot be used as the basis of acceptance.
Minimum loss	This amount is added to the estimated splice loss originally calculated. When splicing special or dissimilar fibers, a high actual splice loss may occur even with optimized arc conditions. To make the estimated splice loss match the actual splice loss, set the minimum loss to the difference value.
Loss Limit	An error message is displayed if the estimated splice loss exceeds the set loss limit.
Core angle limit	An error message is displayed if the bend angle of the two fibers spliced exceeds the selected threshold (Core angle limit).
Cleave angle limit	An error message is displayed if the cleave angle of either the left or right fiber ends exceeds the selected threshold (cleave limit).
Gap position	Sets the relative position of the splicing location to the center of electrodes. Splice loss may be improved in the case of dissimilar fiber splicing by shifting [Gap position] towards a fiber whose MFD is bigger than the other fiber MFD.
Gap	Set the end-face gap between the left and right fibers at the time of aligning and pre-fusion discharge.
Overlap	Set the overlap amount of fibers at the fiber propelling stage. Relatively small [Overlap] is recommended if [Preheat Arc Value] is low, while relatively large [Overlap] is recommended if [Preheat Arc Value] is high.
Cleaning Arc time	A cleaning arc burns out micro dust on the surface of the fiber with an arc discharge for a short period of time. The duration of the cleaning arc can be changed by this parameter.
Preheat Arc value	Set the pre-fuse arc power from the beginning of the arc discharge to the beginning of fibers propelling. If "Preheat Arc Value" is set too low, axial offset may occur if cleaved angles are poor. If "Preheat Arc Value" is set too high, fiber end faces are fused excessively and splice loss increases.
Preheat Arc time	Set the pre-fuse arc time from the beginning of arc discharge to the beginning of fibers propelling. Long [Preheat Arc Time] and high [Preheat Arc Value] lead to the same results.
Fuse Arc value	Sets Arc power.
Fuse Arc time	Sets Arc time.

Chapter 4 - Splice Option

4.1 Splice Mode Setting

- 1 Select [Splice option] in the Splice Mode Menu.
- 2 Select the parameter to change.

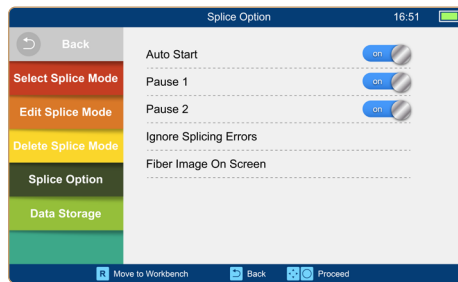

Parameter	Description
Auto start	If "Auto start" is set to ON, splicing starts automatically as soon as the windproof cover is closed. Fibers should be prepared and placed into the splicer in advance.
Pause 1	If "Pause 1" is set to ON, splicing operation pauses when fibers enter the gap-set position. Cleave angles are displayed during the pause.
Pause 2	If "Pause 2" is set to ON, splicing operation pauses after the fiber alignment is completed.
Ignore splice error	
Cleave angle	Setting to "OFF" ignores the faults and continues to complete the splicing even if the listed error appears.
Core angle	
Loss	
Fat	
Thin	
Fiber image on screen	
Pause 1	Sets the display method of the fiber images on the screen during different stages of the splicing operation.
Align	
Pause 2	
Arc	
Estimate	
Gap set	

Chapter 5 - Heater Mode

The splicer provides max 32 heat modes, including 7 heat modes preset by INNO Instrument, which can be modified, copied and removed by user.

Select a heating mode that best matches with the protection sleeve used.

For each type of protection sleeve, the splicer has its optimal heating mode. These modes can be found in the heater mode interface for reference. You can copy the appropriate mode and paste it to a new custom mode. Users can edit those parameters.

5.1 Selecting Heater Mode

Select [Select Heat Mode] in [Heater Mode] menu.

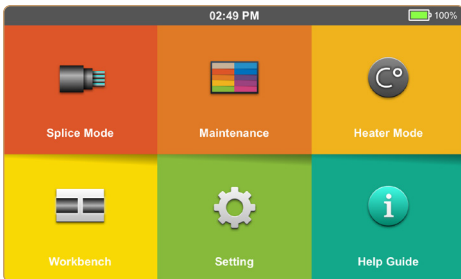

Select [Heater Mode] menu.

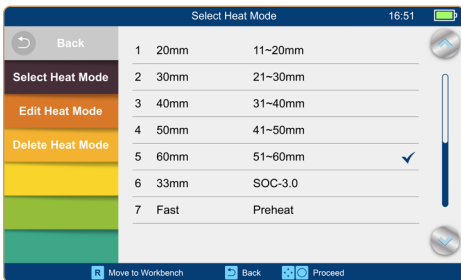

Select heat mode.

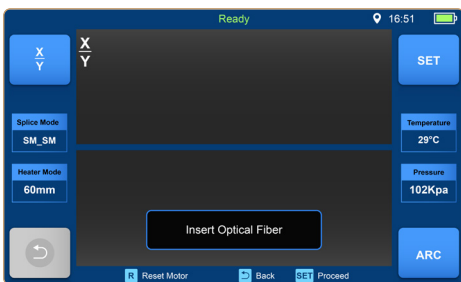

Selected heat mode appears on the screen. Press [R] button to return to the initial interface.

5.2 Editing Heat Mode

Heating parameters of the heating mode can be modified by the user.

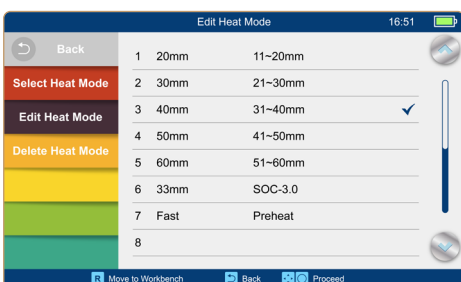

Select [Edit Heat Mode] in [Heater mode] menu.

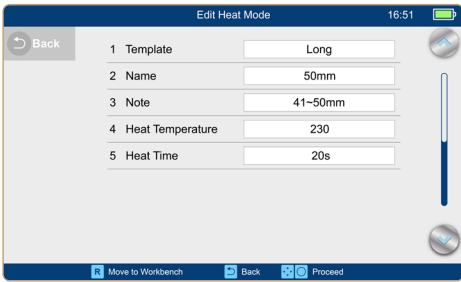

Select the parameters to modify

5.3 Delete Heat Mode

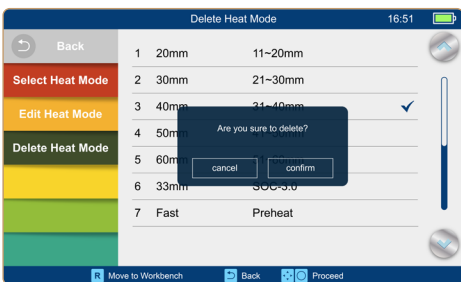

Select [Heater Mode] menu.
Select [Delete Heat Mode].
Select the heat mode to be deleted

Note:

The grayed-out modes (20mm, 30mm, 40mm, 50mm, 33mm) are the system presets which cannot be deleted

Heat Mode Parameters

Parameter	Description
Template	Sets the sleeve type. List of all heat modes is displayed. Selected mode will be copied to the new mode
Name	Title of the heat mode.
Heater temperature	Sets the heating temperature.
Heater time	Sets the heating time.
Preheat temperature	Sets the preheat temperature.

Chapter 6 - Maintenance Menu

The splicer has multiple functions to perform routine maintenance. This section describes how to use the maintenance menu.

Select [Maintenance Menu].

Select a function to perform.

6.1 Maintenance

The splicer has a built-in diagnostic test function that allows the user to evaluate several critical variable parameters in only one simple step. Perform this function in case of splicer operation issues.

Operation Procedure

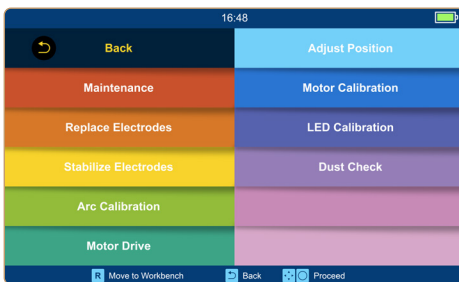

Select [Maintenance] in [Maintenance Menu]

Execute [Maintenance], then the following checks will be made.

No.	Check Item	Description
1	LED calibration	Measure and adjust the brightness of the LED.
2	Dust Check	Check the camera image for dust or dirt and evaluate whether they disturb fiber assessment. If contamination is detected, press the return button twice to display its location.
3	Adjust Position	Automatic fiber adjustment
4	Motor Calibration	Automatically calibrates the speed of 4 motors.
5	Stabilize Electrodes	Accurately measures the position of the electrodes by ARC discharge.
6	Arc Calibration	Automatically calibrates the arc power factor and fiber splicing position.

6.2 Replace Electrodes

As electrodes get worn out during the splicing process over time, oxidation on the tips of electrodes should be regularly checked. It is recommended that the electrodes are replaced after 4500 arc discharges. When the number of arc discharges reaches a count of 5500, a message prompting to replace the electrodes is displayed immediately after turning on the power. Using worn-out electrodes will result in higher splice loss and reduced splice strength.

Replacement Procedure

Select [Replace Electrodes] in [Maintenance Menu].

Instruction messages will appear on the screen. Then, turn off the splicer.

Remove the old electrodes.

- I) Remove the electrode covers
- II) Take the electrodes out of the electrode covers

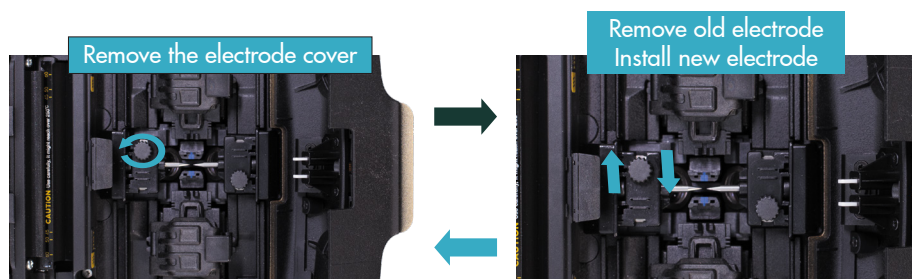

Clean the new electrodes with alcohol soaked clean gauze or lint-free tissue, and install them in the splicer.

- I) Insert the electrodes into the electrode covers.
- II) Reinstall the electrode covers in the splicer, and tighten the screws.

⚠ Note:

Do not over tighten the electrode covers.

INNO Instrument strongly recommends all users to perform [Stabilize Electrodes] and complete an [Arc Calibration] after electrode replacement to maintain good splice results and splice strength (details are described below).

6.3 Stabilize Electrodes

Operation Procedure

- Select [Stabilize electrodes].
- Place prepared fibers into the splicer for splicing.
- Press [S] button, and the splicer will begin to stabilize the electrodes automatically in the following procedures:
 - Repeat arc discharge five times to measure the arc position.
 - Perform splicing 20 times consecutively to precisely establish the electrodes position⁶

6.4 Motor Calibration

Motors are adjusted in the factory before shipping, however their settings may need to be calibrated over time. This function automatically calibrates the press motors.

Operation Procedure

- Select [Motor Calibration] in [Maintenance Menu].
- Load prepared fibers into the splicer and press [Set] button.
- Press motors are automatically calibrated. Upon completion, a success message will be displayed.

⚠ Note:

* Perform this function when "Fat " or "Thin" error occurs, or fiber alignment or focusing takes too much time.

6.5 Arc Calibration

Operation Procedure

- After you have selected [Arc Calibration] in the maintenance menu, an image of [Arc Calibration] will be displayed on the screen.
- Set prepared fibers on the splicer, press [Set] button to begin ARC Calibration.

⚠ Note:

* Use standard SM fiber for arc calibration. * Ensure the fibers are clean. Dust on the fiber surface affects arc calibration.

After Arc calibration, 2 numeric values will be displayed on the screen. When values on the right side are 11 ± 1 , the splicer will prompt out message for completion, otherwise the fibers need to be cleaved again for Arc Calibration till message until the operation is completed successfully.

Through image analysis, the splicer detects dust and contaminants on the splicer cameras, and lenses that may result in improper fiber detection. This function checks the camera images for the presence of contaminants and evaluates whether they will affect the quality of splicing.

Operation Procedure

- Select [Dust check] in [Maintenance menu].
- If fibers are placed in the splicer, remove them and press [Set] to start the dust check.
- If dust is detected during the dust check process, the message "Failed" will be displayed on screen. Then clean the lenses, and [Dust check] until the message "Complete" is shown on screen.

Note:

If contamination still exists after cleaning the objective lenses, please contact your nearest sales agent.

Electrodes are recommended to be replaced with new one when the Current Arc Count exceeds 5500 to ensure splice quality.

- Enter into [Maintenance Menu] > [Replace Electrodes] > [Electrode Thresholds].
- Set electrode caution and electrode warning.

Parameter	Description
Electrode caution	When the discharge count of electrode is more than the set number, message "Caution! Replace electrodes" will appear as you start the fusion splicer. The parameter is recommended to be set as "4500".
Electrode warning	When the discharge count of the electrode is more than set number, message "Warning! Replace electrodes" will appear as you start the fusion splicer. This parameter is recommended to be set as "5500".

Update Software

- You will need to go to the View 5X product page on www.innoinstrument.com and download the updated software file from this page.
- Once downloaded, upload the file onto a USB drive.
- Then plug the USB drive into the splicer and upload the files.
 - Select [Update Software] in the [System Setting] interface.
 - After you have clicked [OK], the splicer will automatically start the upgrade process.
 - The splicer will restart after the upgrade is complete.

Chapter 7 - View Pro Manager & Device Control

The View Pro Manager (VPM) is a comprehensive cloud-based platform designed to efficiently organize and manage fusion splicing projects and related assets. It provides tools for project management, asset tracking, and data analysis, ensuring seamless integration and coordination across various splicing activities. The VPM is compatible with our splicers, including the View Pro, View X, and M+ Series, allowing users to optimize their workflow and enhance productivity through streamlined data management and real-time monitoring capabilities.

7.1 How to Register your Device

You will need to install a SIM Card into your Fusion Splicer

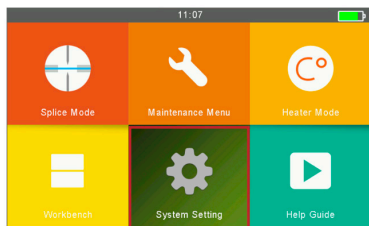

1. Go to [System Setting]

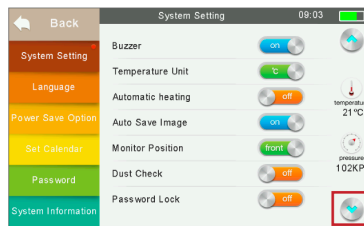

1. Scroll down to the second page

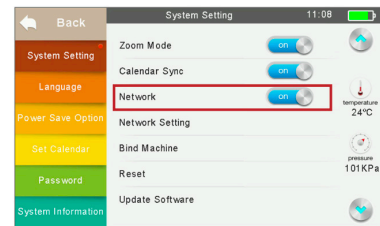

1. Make sure "Network" is **ON**

The current network status can be verified in the Workbench
GPS signal may not be available indoors.



Icon	Description	Icon	Description
	GPS is activated		Attempt to activate Network
	GPS is not activated		No SIM Card
	Network is activated		LBS is activated

If the network activation fails, go to "Network Settings" and enter the APN details manually. Refer to your SIM card provider for the correct APN details

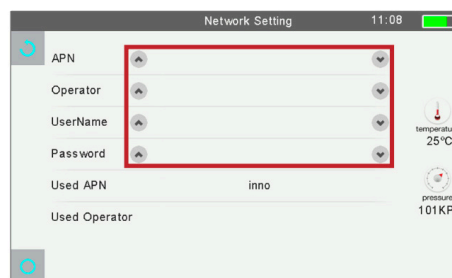
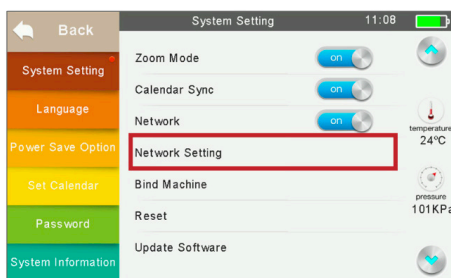

The GPS and Network functions are switched on by default. You can change the connectivity options in “System Setting” -> “Network ON/OFF” and “GPS ON/OFF”.

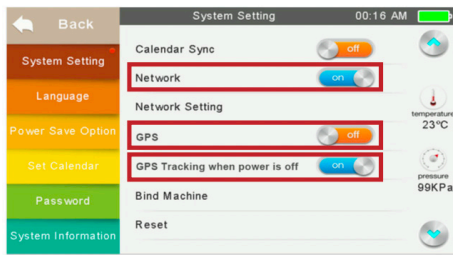

Tracking is also available when the device is switched off with the battery installed. You can change this function with the “GPS Tracking when power is off” option.

7.2 Calendar Sync

- Within the settings on the [Main Menu] of the splicer you will be able to [Set Calendar]
- By activating Calendar Sync, the fusion splicer will be set to the local network time automatically
 - When Calendar Sync is activated, Calendar cannot be manually edited

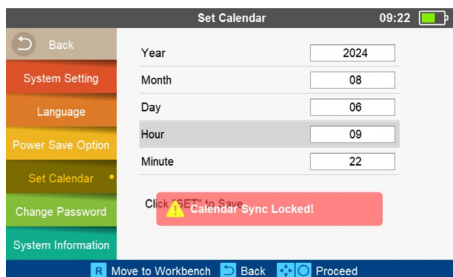

7.3 Supervisor Mode

- Go to [Main Menu] and [System Information]
- In order to access the Supervisor Mode Menu press 5 x [System Information]
 - There is no default password. Leave the Password blank for the initial set up

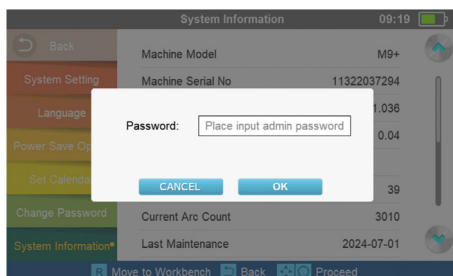

7.3.1 Menu Lock

When in the Supervisor Mode Menu, Menu Lock allows you to restrict access to different settings

- **Lock Home Menu:** Restrict access to Main Menu
- **Lock Splice Mode Menu:** Restrict access to entire Splice Mode menu
 - **Lock Select Splice Mode:** Restrict access to select Splice Modes
 - **Lock Edit Splice Mode:** Restrict access to edit the Splice Modes
 - **Lock Delete Splice Mode:** Restrict access to delete the Splice Modes
 - **Lock Ignore Error Menu:** Restrict access to turn on/off the ignoring error options
 - **Lock Delete Splice Record:** Restrict access to delete Splice Records
- **Lock Maintenance Menu:** Restrict access to the Maintenance Menu
- **Lock Heater Mode Menu:** Restrict access to Heater Mode Menu
 - **Lock Select Heater Mode:** Restrict access to edit Heater Modes
 - **Lock Edit Heater Mode:** Restrict access to edit Heater Modes
 - **Lock Delete Heater Mode:** Restrict access to delete Heater Modes
- **Lock System Setting Menu:** Restrict access to the access the System Setting

7.3.2 System Settings in Supervisor Menu

- Within the System Settings in [Supervisor Menu] you are able to reset the system to the factory settings
- **Apply Global Cleave Angle Limit:** Enter the Cleave Angle to limit the splice operation or pop-up the error message when cleave angle is greater than the applied value.
- **Initial Arc Calibration:** Activate the function to force the Arc Calibration procedure once a day
- **Prevent Splice Error Ignore:** Restrict the ability to override fibre defect and proceed with splicing
- **Prevent Cleave Angle ERR Ignore:** Restrict the ability to override cleave angle errors and proceed with splicing
- **Prevent Arc Repetition:** Restrict the function to generate another arc after splicing

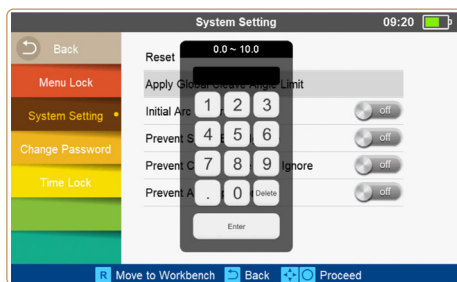
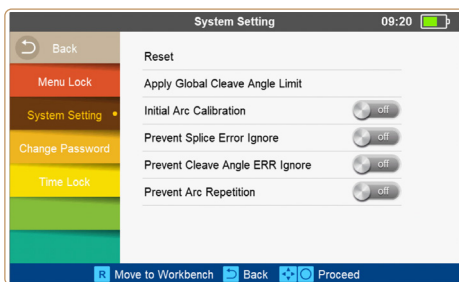

7.3.3 Change Password in Supervisor Menu

- Within the System Settings in [Supervisor Menu] you are able to set a new Supervisor's Password
 - There is no default password. Leave the Password blank for the initial set up
 - You are able to set a password using a combination of letters, numbers and special characters, up to 8 characters

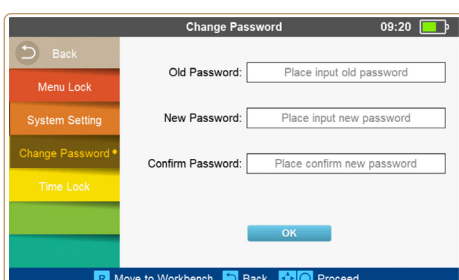

7.3.4 Time Lock in Supervisor Menu

- Supervisor can set a password and specify the date when the machine will automatically lock
- Press "+" button to add new entry, or "x" button to delete an existing entry
- Maximum of 6 different time-locks can be defined

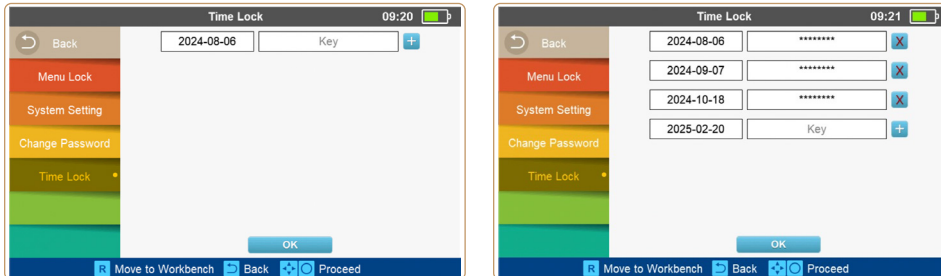

7.4 Service Request

- Within the [Maintenance Menu] you can now submit a Service Request
- To send a Service Request press the "OK" button which will send your request to the INNO Instrument Customer Service Team

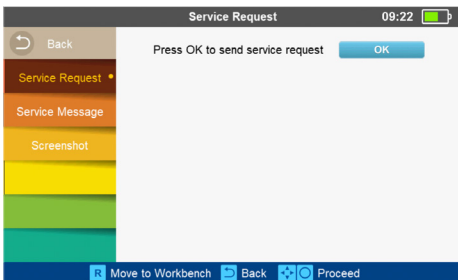

- INNO Instrument Customer Service Team will confirm the issue through the remote diagnosis system
- A message will remain on the splicer to guide the user through the steps to resolve the issue
- Pressing the "OK" button does not provide feedback immediately. If you do not receive any message from INNO, please press the request button again or contact one of INNO's Authorized Partners or INNO Instrument Customer Service Team directly.

7.4.1 Service Message

- All messages from the View Pro Manager are saved in this menu
 - This includes direct messages, server system messages and INNO Customer Service messages

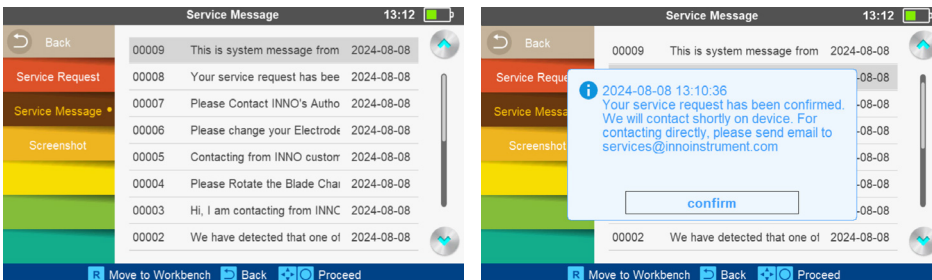

7.4.2 Screenshot

- To screenshot, quickly press the "Power Button" twice.
- The current display will be captured and saved in the [Screenshot] section
- To upload the image to the View Pro Manager server, click the [Upload] button
 - If the button to the right changes to Green, the image has successfully been uploaded to the server
 - If the button to the right is blue, the image is still being uploaded

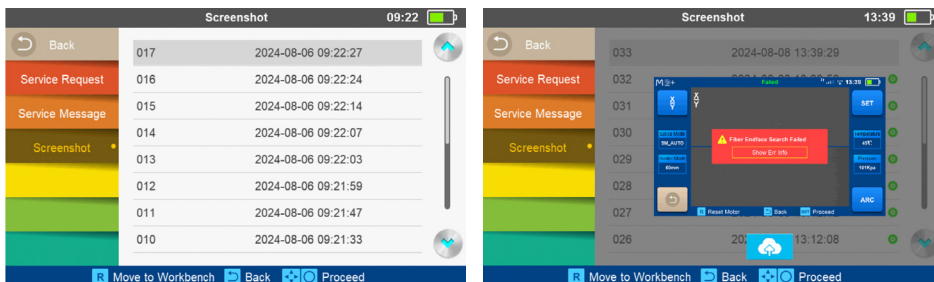

7.4.3 Messaging

- Your splicer can receive messages from the View Pro Manager system
- When a message is received, you will see a message icon displayed in the top bar
- You will need to re-enter the workbench to see the message, the message will be displayed as a pop-up



Chapter 8 - Utilities

8.1 System Setting

Parameter	Description
Buzzer	Sets the sound buzzer.
Temperature Unit	Sets the unit of temperature.
Automatic Heating	If set to [On], when the fiber is placed into the heater. The heater will automatically execute heating.
Dust Check	Checks if there is dust in the imaging area. Sets the dust check function, OFF by default. If set to ON, dust check will be performed automatically when the splicer is turned on.
Pull Test	Sets the pull test, ON by default, if set to OFF, pull test will not be performed.
White LED	White LED switch.
Password Lock	Enables the password protection.
Reset	Restores the factory settings.
Update Software	Splicer software update procedure.
Language	Sets the system language.
Power Save Option	Sets the time of [Monitor Shut Down], time of [Splicer Shut Down] and LCD brightness.
Set Calendar	Sets the system time.
Change password	Password change option. Default password 0000.

Power Save Option

If the power saving function is not set during the use on battery, the number of splice cycles will decrease.

- (1) Select [Power Save Option] in [System Setting] menu.
- (2) Change the times of [Monitor Shut Down] and [Splicer Shut Down]

Parameter	Description
Monitor Shut Down	To save battery power, turning on this feature will automatically turn off the screen if the splicer is not in use the set time. When the screen turns off, you'll see a blinking light next to the power button. Press any key to turn the screen back on.
Splicer Shut Down	Automatically shuts down the splicer's power if it stays inactive for the set time. This helps avoid draining the battery.







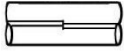

8.2 System Information

After selecting [System Information], the following messages will be shown on the screen:

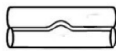
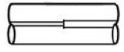
Parameter	Description
Machine Serial NO.	Displays the fusion splicer's serial number.
Software Version	Displays the fusion splicer's software version.
FPGA Version	Displays FPGA's version.
Total Arc Count	Displays total arc discharge count.
Current Arc Count	Displays arc discharge count for the current set of electrodes.
Last Maintenance	Displays the last maintenance date.
Production Date	Displays the production date.

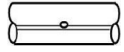
Appendix I

High Splice loss: Cause and remedy

Symptom	Name	Cause	Remedy
	Fiber core axial offset	There's dust in the V-grooves and/or fiber tips	Clean the V-grooves and fiber tips
	Fiber core angle error	There's dust in V-grooves and fiber hammer	Clean the V-grooves and fiber hammer
		Bad fiber end-face quality	Check the cleaver
	Fiber core bending	Bad fiber end-face quality	Check the cleaver
		Pre-fuse power too low or pre-fuse time too short.	Increase [Pre-fuse Power] and/or [Pre-fuse Time].
	The mode field diameters mismatch	Arc power not adequate	Increase [Pre-fuse Power] and/or [Pre-fuse Time].
	Dust combustion	Bad fiber end-face quality	Check the cleaver
		Dust still present after cleaning fiber or cleaning arc.	Clean fiber thoroughly or increase [Cleaning Arc Time]
	Bubbles	Bad fiber end-face quality	Check the cleaver
		Pre-fuse power too low or pre-fuse time too short.	Increase [Pre-fuse Power] and/or [Pre-fuse Time].
	Separation	Fiber stuffing too small	Perform [Arc Calibration].
		Pre-fuse power too high or pre-fuse time too long.	Decrease [Pre-fuse Power] and/or [Pre-fuse Time].
	Fat	Fiber stuffing too much	Decrease [Overlap] and Perform [Arc Calibration].
	Thin	Arc power not adequate	Perform [Arc Calibration].
		Some arc parameters not adequate	Adjust [Pre-fuse Power], [Pre-fuse Time] or [Overlap]
	Splicing line	Some arc parameters not adequate	Adjust [Pre-fuse Power], [Pre-fuse Time] or [Overlap]

⚠ Note:

When splicing various optical fibers with different diameters or multi-mode fibers, a vertical line, referred to as "splicing lines," may appear. It's important to note that this does not impact the quality of splicing, including splicing loss and splicing strength.

Appendix II

Error Message List

While using the splicer, you might encounter an error message on the screen. Follow the solutions listed below to address the issue. If the problem persists and cannot be resolved, there may be faults in the fusion splicer. In such cases, it is advisable to consult with your sales agency for further assistance.

Error Message	Cause	Solution
Left Fiber Place Error Right Fiber Place Error	The fiber end-face is placed on or beyond the electrode centerline.	Press the "R" button, and set the fiber end-face between the electrode centerline and the V-groove edge.
Press Motor Distance Over Limit	The fiber is not set correctly in the V-groove. The fiber is not located in the Camera's field of view.	Press the "R" button and re-position the fiber again.
Press Motor Error	The motor may be damaged.	Consult your nearest INNO Technical Team.
Search Fiber End face Failed	The fiber is not set correctly in the V-groove.	Press the "R" button and re-position the fiber again.
Arc Failure	Arc Discharge did not occur.	Ensure the electrodes are in the correct position. Replace the electrodes.
Align Motor Distance Over Limit	The fiber is not set correctly in the V-groove.	Press the "R" button and re-position the fiber again.
Search Fiber Clad Failed	The fiber is not set correctly in the bottom of the V-groove.	Press the "R" button and re-position the fiber again.
Fiber Clad Gap Wrong	There's dust or dirt on the fiber surface	Prepare the fiber (stripping, cleaning and cleaving) again.
Unknown Fiber Type	There's dust or dirt on the fiber surface	Prepare the fiber (stripping, cleaning and cleaving) again.
	Mismatch Fibers	Use an appropriate splice mode other than AUTO splice mode to re-splice.
	Non-standard optical fibers	AUTO splice mode can only identify the standard fibers such as SM, MM, NZ.
Fiber Clad Over Limit	The fiber is not located in the Camera's field of view.	Adjust the fiber position and complete [Motor Calibration] for maintenance.
Focus Motor Home position Error	The fusion splicer is hit by force during splicing operation.	Carry out [Motor Calibration] for maintenance. If the problem still can't be solved, contact with your local INNO Technical Team.
Fiber End face Gap Wrong	Too much [Overlap] setting	Adjust or initialize [Overlap] setting.
	The motor is not calibrated	Do [Motor Calibration] maintenance.
Motor Distance Over Limit	The fiber is not set correctly in the V-groove.	Press the "R" button and re-position the fiber again.
	There's dust or dirt on the fiber surface	Prepare the fiber (stripping, cleaning and cleaving) again.
	There's dust or dirt on the fiber surface	Execute the [Dust Check] after cleaning the lenses and mirrors.
Fiber Mismatch	The fibers on the two sides are not the same	It may result in large splice loss if you continue to splice, Please use the proper splice mode corresponding to the fibers.
Cleave Angle Over Limit	Bad fiber end-face	Prepare the fiber (stripping, cleaning and cleaving) again. Check the condition of the fiber cleaver. If the blade is worn, rotate the blade to a new position.
	[Cleave Limit] is set too low.	Increase the "Cleave Limit" (standard value: 3.0°)
Core Angle Over Limit	[Offset Limit] is set too low.	Increase the "Core Angle Limit" (standard value: 1.0°).
	Dust or dirt is on the V-groove or the clamp chip.	Clean the V-groove. Prepare and reposition the fiber again.

Fiber Axis Align Failed	Axial offset (>0.4um)	Prepare the fiber (stripping, cleaning and cleaving) again.
	The motor is not calibrated	Do the [Motor Calibration] maintenance.
Fiber is Dirty	There's dust or dirt on the fiber surface	Prepare the fiber (stripping, cleaning and cleaving) again.
	Dust or dirt is on the lens or LEDs	Execute the [Dust Check]. If dust or dirt exists, clean the lenses or LEDs
	"Cleaning Arc time" is too short	Set the "Cleaning Arc time" to 180ms
	Align the difficult-to-locate core fibers using the core alignment method during splicing.	Splice the fibers whose cores are difficult to find by MM splice mode (cladding layer alignment).
Fat Splicing Point	Too much [Overlap] setting	Adjust or initialize "Overlap" setting.
	The motor is not calibrated.	Calibrate the arc power with the [Arc Calibration] function.
Thin Splicing Point	Inadequate arc power	Calibrate the arc power with the [Arc Calibration] function.
	Pre-fuse power or time is set too high	Adjust or initialize "Pre-fuse Power" or "Pre-fuse Time" settings.
	Insufficient "Overlap" setting	Adjust or initialize [Overlap] setting

Appendix III

The solutions for some common problems are provided below for your reference. If you are unable to resolve the issues, please reach out to the manufacturer directly for assistance.

1. Power does not turn off when press "ON/OFF" button.
 - Press and hold the key "ON/OFF" until the LED flashes, release the button and the splicer will be turned off.
2. Issues with the splicer only capable of a few splices with a fully charged battery pack.
 - Battery power can diminish over time due to memory effects and extended storage. To address this, it is recommended to recharge the battery after allowing it to fully discharge.
 - The battery pack has reached end of life. Install a new battery pack.
 - Don't use the battery at a low temperature.
3. Error message appears on monitor.
 - Refer to appendix II.
4. High splice loss
 - Clean the V-grooves, fiber clamps, wind protector LEDs, and camera lenses.
 - Replace the electrodes.
 - Refer to appendix I.
 - The splice loss varies according to the cleave angle, arc conditions and fiber cleanliness.
5. Monitor suddenly turned off.
 - Enabling the power-saving function causes the splicer to enter a low-power state after a prolonged period of inactivity. Press any key to take it off of standby.
6. Splicer power suddenly turned off.
 - When you enable the power saving function, the splicer will turn the splicer power off after an extended period of inactivity.
7. Mismatch between Estimated splice loss and Actual splice loss.
 - The estimated loss is a calculated loss, so it can be used for reference only.
 - The optical components of the splicer may need to be cleaned.
8. Fiber protection sleeve does not shrink completely.
 - Extend the heating time.
9. Method to cancel heating process.
 - Press the "HEAT" button to cancel the heating process.
10. Fiber protection sleeve adhered to heating plate after shrinking.
 - Use a cotton swab or a similar soft tip object to push and remove the sleeve.
11. Forgot passwords.
 - Contact your nearest INNO Instrument technical team.
12. No arc power change after [Arc Calibration].
 - The internal factor is calibrated and adjusted for the chosen arc power setting. The arc power displayed in each splice mode remains constant.
13. Forget to put the optical fiber in during the process of maintenance function.
 - You will need to open the windproof cover and place the prepared fibers in the V-groove and press the "SET" or "R" button to continue.
14. Fail to upgrade
 - When users use the "new" USB Drive to upgrade, the splicer may not be able to correctly identify the upgrade program file; you need to reset the USB Drive, and restart the splicer.
 - Check whether the upgrade file name and the format are correct.
 - If you cannot solve the problems, please contact the manufacturer directly.
15. Others
 - Please contact the manufacturer directly.

The End

* Products models and specifications are subject to change without prior notice.



Copyright © 2024 INNO Instrument Inc. All rights reserved.

INNO Instrument Inc.
support@innoinstrument.com

[Homepage](http://www.INNOinstrument.com)
www.INNOinstrument.com

[Please visit us on Facebook](https://www.facebook.com/INNOinstrument)
www.facebook.com/INNOinstrument